

**The digital  
enlightenment**

How data creates  
new value

---

# changes

What's driving the  
process industry

#2/22

Digitalization makes it possible to acquire, send and process more and more data. But value is created only when the right information is available at the right time and in the right place: that is, when users in the process industry are able to make better decisions as a result of newly created knowledge.

# New insights into the process

Making process data available through field instruments has been at the core of Endress+Hauser's expertise for 70 years. We have consistently helped our customers to acquire the information they need for decision-making from their process applications. What we are now experiencing in the process industry is a real game changer, however, because digitalization is unlocking completely new opportunities to acquire, transmit and process data.

Powerful processors analyze sensor signals to identify maintenance needs, process disruptions and more. Ethernet and other communications technologies provide fast and secure transmission. Algorithms and artificial intelligence make it possible to manage and analyze even the largest volumes of data in an automated and cost-effective way. What it ultimately comes down to is gleaning useful information from the data and generating new knowledge through the linking of information.

Nevertheless, the radical change I'm referring to is more evolution than revolution. Although we see how new data-driven business models are increasingly finding their way into our sector, the transition is taking place at a much slower pace than expected. This is due to the long life cycles of plants and instruments, as well as the process industry's stringent security requirements, including cybersecurity. It also has to do with the fact that every new solution first has to prove its value.

After all, good decisions are made not by collecting as much data as possible, but by having the right data that provides valuable information and broadens our insight. These are the types of solutions we are working on, together with our customers and partners. In this edition of 'changes' you will find many examples of how data is already creating new value – by helping to make processes better, more secure, more cost-effective and more eco-friendly.

Here's wishing you a stimulating read!

Yours

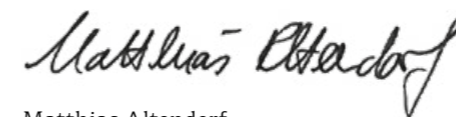

Matthias Altendorf  
CEO of the Endress+Hauser Group



*Good decisions are made not by collecting as much data as possible, but by having the right data.*

# Hunting for treasure



Data is the key ingredient for the digital transformation of industry. **Page 8**

# The great unknown



Big data in everyday life: why diapers and beer are connected. **Page 4**

# “The family has to play an active role”



Sandra Genge and Matthias Altendorf discuss the role of the shareholder family at Endress+Hauser. **Page 44**

# Doing more with data



In many applications, it's data that makes the crucial difference. **Page 26**

# “Standards bring down barriers and costs”



A conversation with Frank Stührenberg (Phoenix Contact) and Matthias Altendorf (Endress+Hauser). **Page 14**

# A clever combination



With Netilion, Endress+Hauser provides easy access to Industry 4.0. **Page 18**



# Contents

- 4 **The great unknown** What do diapers and beer have to do with big data?
- 8 **Hunting for treasure** Connecting the physical world of sensors with virtual applications opens up powerful opportunities for the process industry.
- 14 **“Standards bring down barriers and costs”** Frank Stührenberg, CEO of Phoenix Contact, and Endress+Hauser CEO Matthias Altendorf discuss digitalization and decarbonization of industry.
- 18 **A clever combination** The Netilion IIoT ecosystem lightens the workload for Endress+Hauser customers – by automatically converting field data into valuable information.
- 26 **Doing more with data** Many companies in the process industry still do not make use of the data generated by their plants. Endress+Hauser helps them to unearth this treasure.
- 28 **The patterns of the world** Data scientist Rebecca Page has one eye on the user, the other on science.
- 29 **The taste of digitalization** With the QWX43, brewers can monitor the fermentation process with no need for manual sampling on site.
- 30 **Clear signals** Devices with Heartbeat Technology sound the alarm when something is wrong and report process disruptions.
- 32 **A clear advantage** Endress+Hauser uses data and artificial intelligence to optimize its own processes.
- 34 **Delivering with agility** Endress+Hauser is developing its cloud-based IIoT ecosystem Netilion in short, sprint-like stages to ensure it continues to meet customers' needs.
- 35 **The treasure trove** Endress+Hauser went paperless 20 years ago and set up a central instrument database.
- 36 **A virtual friend for life** It is the virtual likeness of a real-world object: a digital twin can be used to simulate many functions.
- 38 **Full speed ahead** Committed employees, innovative ideas and sustainable action are the way to a bright future at Endress+Hauser.
- 42 **Simulate, then build** Endress+Hauser uses numerical simulation to develop tools that provide reliable measurements even under extreme conditions.
- 44 **“The family has to play an active role”** What are the shareholder family's plans for the future of Endress+Hauser? Find out from Sandra Genge and Matthias Altendorf.

# The great



It has been said that data can draw inferences between diaper purchases and beer sales. That it can displace oil and identify love. But can it, really? While there is a lot of talk about data – or more accurately, big data – there is a scarcity of knowledge. Before diving into the world of industrial data usage, we'd like to approach the subject from a popular science perspective.

Text: Silke Bauer, Roman Scherer, Alexandra Schröder, Robert Habi  
Photography and graphics: Getty Images, Shutterstock, stocksy

# unknown

# Big data bang



More than 24 times the distance between the Earth and the moon

The surge in digitalization is evident in the global volume of data – the so-called datasphere. In 2010 the aggregate volume of data generated, captured and replicated amounted to 2 zettabytes (that's a figure with 21 zeros). By 2025 the datasphere is expected to grow to a whopping 181 zettabytes, a 90-fold increase since 2010. If you were to store this amount of data on DVDs, the stack of disks (without their cases) would be roughly 9.4 million kilometers high, or more than 24 times the distance between the Earth and the moon.

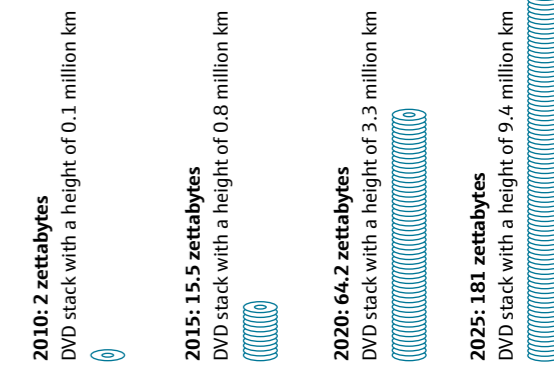

## It all began with the bubonic plague



The principle of viewing data as a source of knowledge is not new. Throughout the centuries, people have attempted time and again to systematically utilize information for decision-making. As far back as 300 BC or so, the ancient Egyptians tried to record all of the data in the works in the Library of Alexandria. The Romans carefully studied statistics related to their military as a means of determining the optimal distribution of armed forces. The first evidence of working with 'big data', as we understand it today, occurred in 1663. While examining death rates in England during the bubonic plague that was then ravaging Europe, John Graunt worked with what was a vast amount of information for the time. That made him one of the first people to employ statistical data analysis.

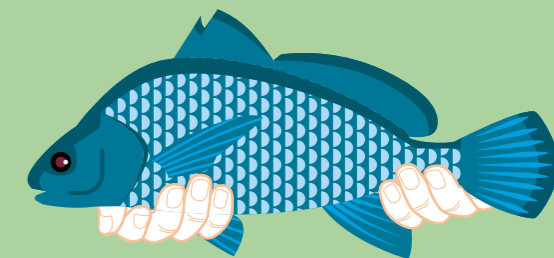

## Fish with fingers

To err is human. That means even artificial intelligence, fed with data from humans, can go wrong. Researchers at the University of Tübingen in Germany trained a neural network to identify images of tench, a species of fish. But when they wanted to know which characteristics the AI technology relied on to identify the fish, and had it show them the most important pixels used for this purpose, they were in for a surprise: a selection of rosy human fingers against a green background. It turned out that most of the images in the dataset showed anglers holding a tench in their hands. That gave the AI technology the wrong idea: it concluded that the fingers were part of the fish.

# Is it already in real time?

Everyone wants it, but only a few can create it.

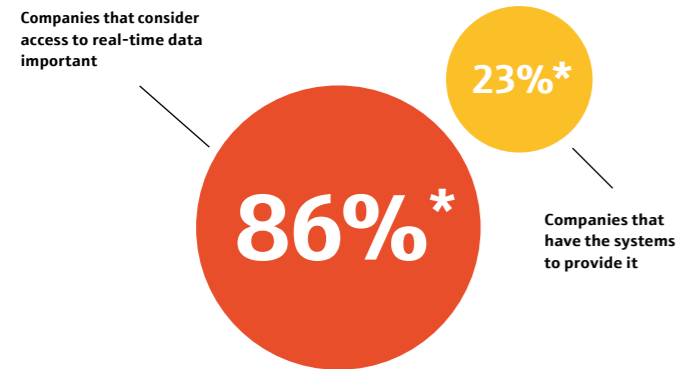

\* Study by Fivetran, 2022.

## Better than oil

Oil, mobile telephony, energy, finance: this is how the world's five largest companies made their money in 2008. Today, four of the five biggest are technology companies, some of which make their money purely with data or cloud services. This illustrates how data beats oil now. You can duplicate it. It's reusable. And it's an almost infinite resource.

Most valuable companies according to market capitalization, 2008 versus 2022 (source: PwC).

2008		2022	
1.	PetroChina	1.	Apple
2.	Exxon	2.	Microsoft
3.	General Electric	3.	Saudi Aramco
4.	China Mobile	4.	Alphabet
5.	ICBC	5.	Amazon

## The dark side of AI

In 2017 Amazon was forced to scrap an algorithm that unintentionally favored male job applicants over female candidates. Another algorithm used within the US justice system calculated inordinately high recidivism rates among Black defendants and offenders, which meant that they tended to receive longer prison sentences than their White counterparts and had less chance of being freed on bail. These are only two examples that suggest data and artificial intelligence are not necessarily objective, because they adopt the biases of their programmers. As Forbes business magazine reported, in the tech industry these workers are 80 percent male and the majority are White. That makes more diversity and less bias in data analysis an important task for the future.

## Data match = love?

Online dating services have been booming for years. But they won't reveal exactly how their algorithms work. The assumption is that the more similar two people are in terms of their values and preferences, the better the chances for a long and happy relationship. Researchers at Northwestern University in Illinois claim this is just a lot of hot air. In the US journal Psychological Science, they explain that personality tests cannot tell how two people will get on or whether their sense of humor is the same. Nor do the tests ask about stressful periods in life or financial problems, which can place strain on a relationship. So for long-term love, it's better to search around in real life.



*"It is clear that we are all drowning in a sea of information. The challenge is to learn to swim in that sea, rather than drown in it."*

Peter Lyman (1940–2007), author and computer scientist at the University of California, Berkeley

# The legend of beer and diapers

While not entirely true, the following is a helpful story that has made the rounds in seminars and literature for decades. According to the legend, in the 90s retail giant Walmart analyzed its sales receipts and discovered a rise in demand for beer and diapers on Friday evenings. Young fathers apparently were taking advantage of the family weekend shopping trip to stock up on a couple of six packs. Creative employees then placed the beer in the vicinity of the infant supplies. Sales went through the roof. Although those involved said there was no correlation between the sales figures and the gender or age of the buyers, the effect is undisputed – and provides a powerful explanation of the principle behind data mining.





# Hunting for treasure

Data is key in the digital transformation of the process industry. But only rarely does data find its way beyond the confines of the devices, machinery and systems that generate it. Now that could all change, thanks to smart field instrumentation, digital interfaces and cloud-based analytical tools. The possibilities are endless, particularly when sensors in the physical world are linked up to artificial intelligence.

Text: Laurin Paschek, Robert Habi, Martin Raab  
Illustration: Julia Praschma

# 50%

of the data generated in production is actually utilized, according to international studies.

Should you have wandered through any large industry trade fair lately, it may have felt like being on a different planet from before. Exhibitors that until recently had stalls full of heavy steel are suddenly presenting themselves as tech companies. All eyes are on the digitalization of production. At the trade booths, the brave new world of Industry 4.0 is very much a reality. And yet, if you visit a process engineering facility – wherever in the world and whatever it manufactures – you will probably see little of this fourth industrial revolution under way. Analog signal transmission continues to dominate the process industry. Even the latest measuring devices tend to transmit their data to control systems using nothing fancier than 4–20 mA current loop technology.

“International studies estimate that only around five percent of the data generated in production actually gets analyzed in depth,” says Dr Rolf Birkhofer, Managing Director of Endress+Hauser Digital Solutions. “That finding closely matches our own experience. Even though Endress+Hauser’s measuring devices have had digital communication capability for years now, the vast majority of our customers have yet to exploit this option.” There are many reasons behind the reticence, including the decades-long life span of process plants and field instrumentation, the fact that those plants often contain components from numerous suppliers, and the strict safety standards and regulations in force across many industries. Given such an environment, convincing customers to adopt new technologies involves bringing some cogent arguments to the table.

#### INDUSTRY AT A TURNING POINT

And yet there are areas of industry where change is afoot, says Birkhofer. The latest generation of smart instruments can supply a wealth of supplementary data alongside their actual measurements, including information on the sensors and processes themselves. There are technologies that provide a secondary channel for rapid, secure data transfer from the field right up to corporate level that is completely distinct from process control in the plant itself. Furthermore, a host of projects have already demonstrated how this data can be turned into useful information and valuable knowledge. “Digitalizing process plants is beginning to emerge more and more from the confines of pilot installations and small-scale projects,” Birkhofer says. And, he adds with conviction, “We are at a turning point.”

For plant operators, it’s all about efficiency, security and quality in the face of competitive pressure and a general shortage of skilled workers. It follows that there is an enormous number of potential use cases. Analyzing data at the level of individual measuring points can already bring significant benefits. But the data generated from instruments and processes only reveals its true value after central aggregation, be that in a cloud application or edge computing system. Aggregation brings scalability to data gathering and processing, with individual use cases no longer requiring their own dedicated software. A further possibility is to link data from the field with other data sources such as weather forecasts and ERP systems, all in real time.

#### VIRTUAL AND PHYSICAL WORLD

A particularly exciting prospect is to combine multiple data sources using artificial intelligence. “Big data applications can glean highly complex insights in fractions of a second, given the right data inputs,” says Florian Falger, Market Manager at the Endress+Hauser Level+Pressure Innovation Lab. One of the team’s activities is finding ways to precisely determine maintenance intervals for measuring instruments and entire plants with the help of specialized algorithms and artificial intelligence. Thus they are laying foundations for something that many companies in the process industry want: predictive maintenance. “Large chemical plants, for example, operate around the clock,” Falger explains. “Even planned maintenance is a costly undertaking. Predictive maintenance would help to minimize the plant downtime involved and avoid unscheduled outages, as well as reduce workload and costs.”



*“Digitalizing process plants is beginning to emerge more and more from the confines of pilot installations. We are at a turning point.”*



**Rolf Birkhofer,**  
Managing Director of Endress+Hauser Digital Solutions

*“Process mining uncovers hidden potential for optimization, because we can take a deep dive into individual process flows by following their digital trails.”*

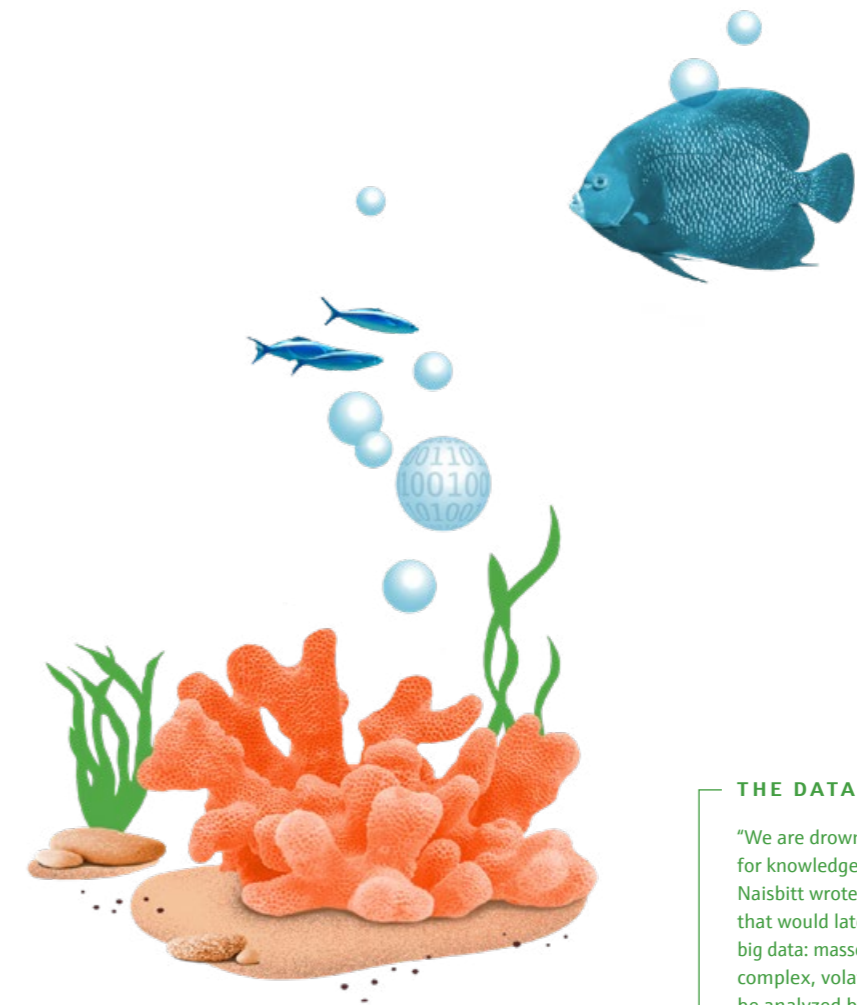

**Stefan Sigg,**  
Management Board member  
at Software AG

Another use case is in-depth analysis of process data as a means to improve the quality of manufactured products or to increase process efficiency. “In manufacturing, deployment of process mining software still holds a lot of untapped potential,” says Dr Stefan Sigg, Management Board member and Chief Product Officer at Software AG, one of Europe’s largest software developers. Process mining uses previously acquired data to replay business and production processes virtually, then analyzes the results from various process instances to find anomalies. It can be a real eye-opener when most processes run according to plan, but some instances take a completely different path. “Those process instances may be wasting money, time or energy,” Sigg says. “Process mining uncovers hidden potential for optimization, because we can take a deep dive into individual process flows by following their digital trails.”

**THE STICKING POINT: INTEROPERABILITY**

The viability of solutions like those developed by Software AG hinges on data from industrial and commercial processes being available in analysis-friendly form. Straightforward and secure data interchange is another essential. Enter the Open Industry 4.0 Alliance, with its goal of ensuring those exact things. The Alliance is a joining of forces between some 100 providers of IT, software, factory and process automation. Their mission:

to promote interoperability among the devices and solutions used by Industry 4.0 applications. “Operators might be using field instrumentation from multiple vendors in the same plant, or even for the same measurement technique,” says Hans-Jürgen Huber, Endress+Hauser’s representative in the Open Industry 4.0 Alliance. “And they expect all of these different devices to be easily integrated and interconnected.” The alliance is working on a reference architecture based on existing standards, consistently applied. “The ultimate goal is for plant operators to deploy our solution and, from there, to make use of data generated by any and all of their instruments.”

Huber is aware of the long road ahead to international or even global standards, but the IIoT expert is nonetheless optimistic: “Take the example of screw threads, where it took decades to come up with industry-wide standards. Developing uniform standards in the data space will be a much quicker process.” The pace of progress is due in no small part to tremendous and ever-growing pressure on the process industry driven by environmental concerns and climate change, the energy transition and electrification. “It’s a question of when, not if, the valuable treasure trove of data in our customers’ use cases gets leveraged,” Birkhofer says with certainty. “Everything that can be digitalized will be digitalized.”

**THE DATA PROSPECTORS’ GOLD**

“We are drowning in information but starved for knowledge.” What US futurologist John Naisbitt wrote in 1982 described a challenge that would later cause a furor in the age of big data: masses of information that is too large, complex, volatile or poorly structured to be analyzed by conventional data processing methods. It takes other means, such as smart analytical processes from the world of data science.

Data mining promises leaps in innovation across many areas of life. For example, online stores that monitor our mouse clicks so that they can offer us products tailored to our interests. In medicine, algorithms ease diagnosis and allow patient-customized treatments. And thanks to artificial intelligence, self-driving vehicles will be able to navigate busy intersections safely, even faced with oncoming traffic – a surprisingly complex task from an IT perspective.

The process industry also generates reams of data from measuring instruments, drives, valves and so on. These measurements, sensor signals and device parameters are used to control the processes themselves, but then there’s more: analyzed and linked together, they can also be used as a basis for a broad spectrum of insights concerning instruments, processes and plants – providing opportunity to transform strictly defined and mostly rigid value chains into flexible, dynamic and globally integrated networks for value creation.





## “Standards bring down barriers and costs”

Data helps industry to optimize production – and is essential for the transition to a sustainable energy supply. But more standardization is needed, say Frank Stührenberg, CEO of Phoenix Contact, and Endress+Hauser CEO Matthias Altendorf.

Questions: Laurin Paschek  
Photography: Andreas Zimmermann

**Mr Stührenberg, Phoenix Contact recorded strong growth in 2021 and is expected to repeat this performance in 2022. How are you achieving that in times like these?**

**Stührenberg:** Truly, I don't think we've ever had growth exceeding 20 percent for two years in a row. Under the current circumstances, that's indeed remarkable. My general view is that we're seeing a substantial growth phase in both electrical and process engineering, which will continue for a long time to come.

**Why is that?**

**Stührenberg:** A number of developments are now converging and synergizing. One of them is decarbonization and the related electrification of the economy and society. To build a fossil-free world, we need accurate data on energy consumption. We must also get transport, energy, buildings and industry all hooked up together. Another development is the labor shortage brought on by changing demographics. More automation will help us respond to the scarcity of skilled workers. A third trend is the move toward greater resilience. That requires redundancy in the form of new factories, outside of China for example. And we supply them with technology.

**Mr Altendorf, Endress+Hauser has also posted considerable growth recently. Have digitalization and connectivity played a role in this?**

**Altendorf:** We have been digitalizing our business for two decades now, and by that we mean joining up various data sources in the process engineering industry. Our sensors generate data that we make available and enrich with supplementary information so that rules-based decisions can be taken using this knowledge. What's new here is the ability to offer this knowledge network-wide to all who can benefit from it. So the more players and data content there are in the network, the more value there is to be gained.

**How did this new situation come about?**

**Altendorf:** One reason is the rising number of mobile devices. Another one is cloud connectivity. The old client-server architectures were not particularly suited to that. Cloud services make it easy for us to provide the data. Data volumes are increasing as a result, while we are seeing the rise of algorithms that process, slice and dice the data to make it usable. Which leads me to the third reason: the dramatically decreasing cost of computing power and bandwidth in recent years. All of this is driving digitalization. Our project volume in this field rose by one third in the first half of 2022.

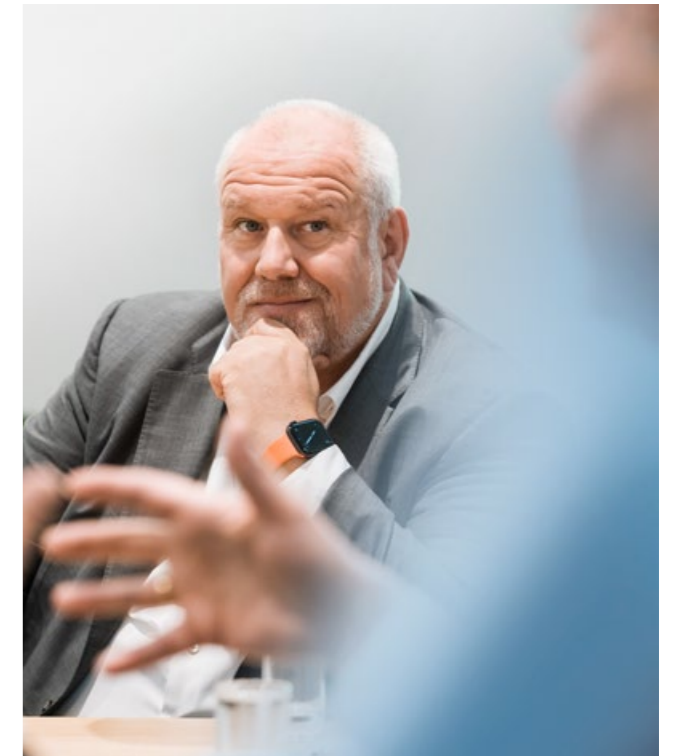

*“An individualistic society is poor at coping with crises – we can only overcome them through concerted action. And that's precisely the strength of family businesses: their power to bond people together.”*

**Matthias Altendorf,**  
CEO of the Endress+Hauser Group

### What opportunities does this create for your customers?

**Altendorf:** We supply them with almost three million sensors a year. Ten percent already have digital twins. These enable our customers to plan more effectively and to operate their plants with greater resilience. There is less unexpected downtime. And our customers can operate more equipment using fewer staff, increasing their productivity.

### Mr Stührenberg, let's take a look at your customers and your product range. How has this developed in digitalization terms?

**Stührenberg:** Our portfolio development has always been very organic. Phoenix Contact has its roots in electrical interconnections. Starting from quite basic connector components, we added the first electronic functions such as relay switching and LED circuitry. This evolutionary path took us forward to automation, which we continue developing today as one of our core activities. The complete transformation of energy supply infrastructure will play a crucial role for us through this decade, and likely into the next.

### What exactly do you mean by that?

**Stührenberg:** It's about more than replacing coal-fired power stations with wind farms. We also need to electrify, digitalize, automate and interconnect every sector of industry. This will be the guiding principle of activity at Phoenix Contact. Which will in turn continue driving our transformation as a company. Key factors here are digital interconnectivity and data exchange, for example in electric vehicle charging or in vehicle-to-grid storage solutions where the car and charging system communicate with the power grid.



*“The game-changer in globalization was the standardized shipping container. This drastically reduced the effort involved in movement of goods; we need to reach a similar place with data exchange as well.”*

**Frank Stührenberg,**  
CEO of the Phoenix Contact Group

**Altendorf:** The electrification that Mr Stührenberg describes is driving decarbonization across industry. Paired with this is the hydrogen economy, because we also need to store the electricity from renewable sources. That can't be done with batteries or pumped storage hydropower alone. Hydrogen is a medium that we can use to readily convert stored energy back into electricity. We can also use hydrogen as a feedstock for producing plastics, fertilizers and other crucial products.

**Stührenberg:** Storing electricity in the form of hydrogen has efficiency drawbacks, but we can overcome these if we produce a plentiful supply of renewable energy. We are currently seeing some promising approaches in the Middle East that use infrastructures and technologies already in place for oil and gas.

### FOCUS ON THE 'ALL ELECTRIC SOCIETY'

Frank Stührenberg was born in 1963 and studied economics with a major in business IT at the University of Paderborn, Germany. He began his career in 1989 at Nixdorf Computer, before joining Phoenix Contact in 1992. He was appointed to the company's Executive Board in 2001 and became CEO in 2015. Phoenix Contact is the global market leader for components, systems and solutions in electrical engineering, electronics and automation. The family-owned business, headquartered in Blomberg, Germany, employs more than 20,000 people worldwide and generated sales of around three billion euros in 2021. Stührenberg is driving Phoenix Contact's development with his vision of the 'All Electric Society'. This involves comprehensive electrification, interconnectivity and automation across all sectors of industry and infrastructure, with the aim of combining climate protection and economic development. In addition to his work at Phoenix Contact, Frank Stührenberg is an honorary board member and treasurer of the German Electro and Digital Industry Association (ZVEI) and a member of the Board of Trustees of the German CEO Alliance for Climate and Economy (Stiftung KlimaWirtschaft).

### What is your experience to date with digital factory solutions in your own manufacturing?

**Stührenberg:** In our pilot plant – an electronics factory – we have seen that digitalizing to the max does not automatically improve production. Rather, that comes down to making production processes as lean and efficient as possible. For which you need real-time process data. This is the only way to find out whether altering a process step will bring the hoped-for success. But collecting this data is of no use by itself. That's why another one of our major focuses is data analytics, so that we can spot when a process is going in the wrong direction.

### What do plant operators expect from Endress+Hauser when it comes to digitalization?

**Altendorf:** There are three main factors. First comes safety: people, machinery and the environment are at risk if the measurement technology in process plants does not work reliably. So it must be functionally safe and well protected against cyberattacks. Second is the domain

knowledge required for linking up IT and OT – information and operating technology. This is particularly important to operation and maintenance. If a replacement for a process-critical instrument would not be immediately available, we must let the plant operators know of a possible problem in good time. The digital twin makes this possible. The third factor is intercommunication among components, in other words their interoperability. Instruments must speak a common language.

**Stührenberg:** The game-changer in globalization was the standardized shipping container: eight feet wide, eight-and-a-half feet tall, 20 or 40 feet long. This drastically reduced the effort involved in movement of goods; we need to reach a similar place with data exchange as well.

**Altendorf:** This is where industry associations, partnerships and alliances play an important role. We make every endeavor to support these activities because open standards bring down barriers and costs – and they help us to concentrate on things that lead to real benefits.

**The coronavirus pandemic is not yet over, and now we are seeing high inflation and geopolitical instability. The war in Ukraine puts Europe at risk of energy shortages, and we are on the brink of a recession. How are you handling this situation?**

**Stührenberg:** I never imagined so many crises being heaped on us in rapid succession. Our industry was already facing headwinds in 2019, and then the pandemic came along in 2020. Come 2022, we had to close our subsidiary in Russia. And we don't know what else lies around the corner. But at the same time, over the past four years Phoenix Contact has seen the biggest growth spurt in the company's history. Like Endress+Hauser, we are a family business that thinks long term; during this period we invested around 750 million euros. Last but not least, we have all grown somewhat more resilient. We are buttressing our supply chains and not letting a little headwind blow us off course. Digital connectivity will continue advancing, and the world of renewable energy will arrive. All this puts me in an upbeat mood.

**Altendorf:** Every crisis is also an opportunity. However dramatic the challenges facing supply chains and energy supply, however catastrophic the war in Ukraine, it also gives us the opportunity to strike out in a new direction, such as transitioning to a sustainable energy supply. On the political front, it enables us to champion a free democratic world with shared values and rules. The past has shown that an individualistic society is poor at coping with crises – we can only overcome them through concerted action. And that's precisely the strength of family businesses: their power to bond people together. This helps us turn crises into opportunities.



# A clever combination

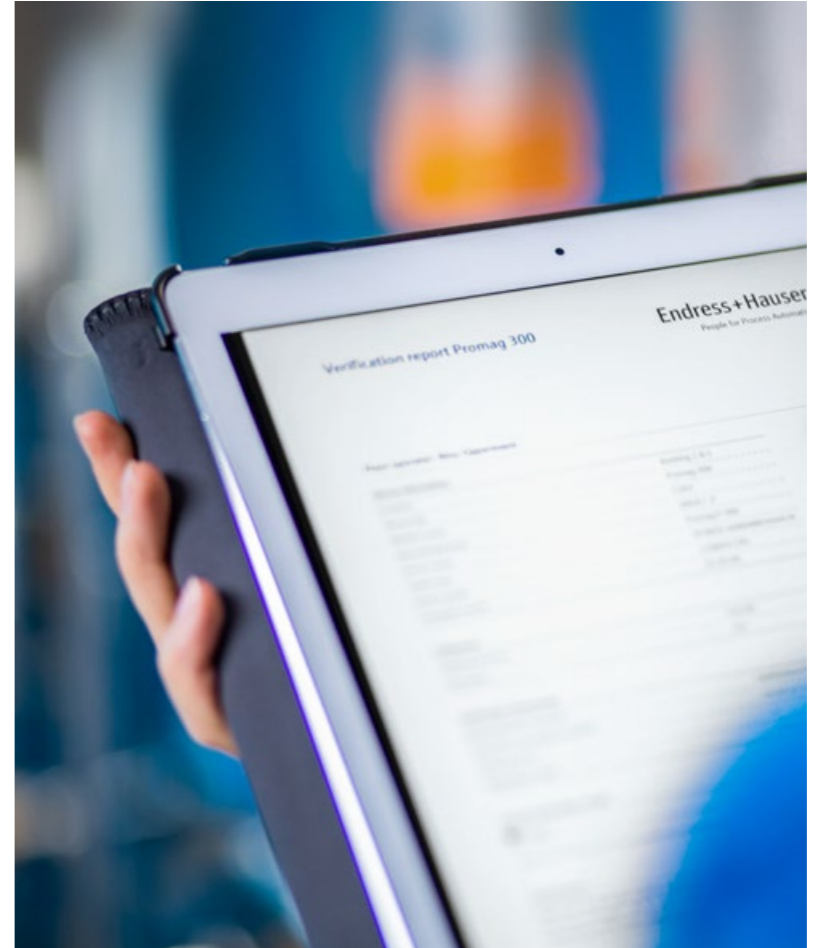

Making better, data-based decisions just got easier thanks to the Netilion IIoT ecosystem from Endress+Hauser. Netilion automates the transformation of data from the field into valuable information. Here are three illustrative examples of customers who already see their everyday business benefitting from the opportunities afforded by Netilion – in terms of improved operation, streamlined maintenance and lower costs.

Text: Silke Bauer, Christine Böhringer, Lisa Schwarz  
Photography: Kristoff Meller, Christoph Fein, Manu Agah, Shutterstock, Waterschap Hollandse Delta  
Graphics: 3st

*“With Netilion we save time and resources. We can do a better job of planning calibration activities, avoid plant downtime and drive down maintenance costs.”*

**Saymon Galaci,**  
Strategic Account Manager at Endress+Hauser Brazil

Progress can sometimes be measured in numbers, for example when taking inventory of the installed base of field instruments in process plants. Carlos Behrends, Managing Director of Endress+Hauser Brazil and Corporate Sales Director for South America, reports: “Two of our service technicians toured the country for six months, developing a calibration concept for the Brazilian branches of a large brewery group. To that end they pinpointed the applicable measuring points at 15 locations. They noted down instrument after instrument on site, drew up lengthy tables, structured them according to specific criteria and analyzed the results in painstaking detail. After Endress+Hauser won the service contract, the two engineers repeated their installed base analysis, this time for every one of the breweries’ 19,000 measuring points. By that time the Netilion IIoT ecosystem had been introduced, which helped them greatly. “With our new digital tools we needed only a fraction of the time and gained much deeper insights into the instruments,” points out Carlos Behrends.

**GAINING TRANSPARENCY**

For the digital installed base analysis, the Endress+Hauser service engineers relied on Netilion Analytics – a digital service embedded in the Netilion IIoT ecosystem – together with the Netilion Scanner app. This uses a smartphone or tablet’s built-in camera to snap an image of the instrument name plate and automatically generate a digital twin from the information printed on it. Netilion Analytics analyzes the transmitted data, links the data for Endress+Hauser instruments to entries in the device database and presents a clear display of results. A dashboard shows key information at a glance. Detail on every instrument is readily retrievable. “We get loads of useful information about the installed base, such as instrument age, availability of spare parts or the extent to which the measurement technology is standardized,” reports Saymon Galaci, Strategic Account Manager for the customer in Brazil. “We can also spot straightaway the criticality of a given measuring point to the process, an important criterion for us when it comes to calibration.”

This newfound transparency aims to improve the maintenance and operation of the customer’s breweries in Brazil. “With Netilion we save time and resources. We can do a better job of planning calibration activities, avoid plant downtime and drive down maintenance costs,” says Saymon Galaci confidently. Regarding the maintenance contract, Endress+Hauser uses the Netilion IIoT ecosystem as a tool for its own service technicians, so they can do the best possible job of fulfilling a customer order. “Our aim is to see the customer renew the contract in five years’ time,” emphasizes Saymon Galaci. He is convinced that sooner or later the group itself will be exploiting the possibilities of digitalization in its brewing operations, just like increasing numbers of plant operators already do today.

**19,000**

measuring points have been digitally captured for the service contract with the 15 Brazilian operations of a global brewery group.



1

- 1 To develop a calibration concept for the instrumentation of a process plant, the entire installed base must first be captured manually or electronically.
- 2 In large plants, measuring devices are installed in countless and sometimes hard-to-access locations, such as these brewery fermentation tanks.
- 3 Which are the operationally critical measuring points? A digital service like Netilion Analytics helps to quickly and reliably pinpoint the instruments concerned.



2



3

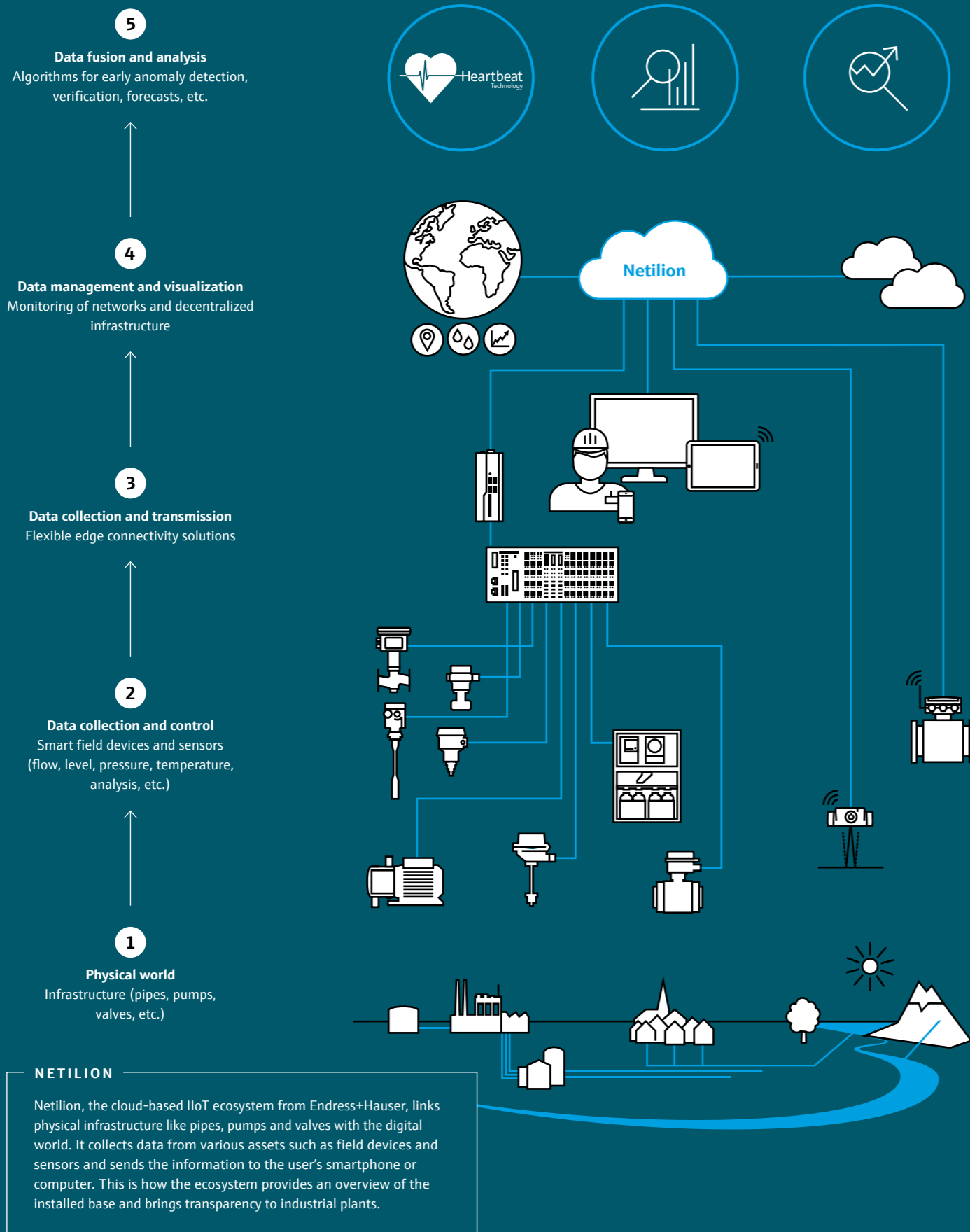

**SCALABLE SOLUTIONS**

“Netilion makes digitalization something tangible for the process industry. By linking the physical and digital domains, our IIoT ecosystem ingests field-level data and then generates valuable information from it,” says Tobias Zubler, Service Product Manager at Endress+Hauser. The full benefits come to fruition with dynamic utilization of process and instrument data. Where field instruments themselves lack the required connectivity, there are adapters or edge devices for opening up an additional secure communications channel. This is a must for using other cloud-based services. “Netilion offers customers a wealth of possibilities, consistently aligned with their needs,” explains Tobias Zubler, who goes on to emphasize: “Our solutions are scalable, starting with basic data transmission from individual measuring points, to utilization of digital services for greater operational efficiency, to a full package where we remotely monitor instruments while assuming responsibility for their service.”

**REMOTE MAINTENANCE**

Management at the Waterschap Hollandse Delta regional water authority went for just such an all-encompassing solution. The authority operates 19 wastewater treatment plants in the southern Netherlands, spread over five islands and the port city of Rotterdam. “The water authority service technicians have more than 270 sensors and analyzers to maintain and service. For instrument inspections, that previously meant driving to individual plants, some of them unstaffed,” explains Julia Grether, IIoT Product Owner at Endress+Hauser. The issue is that these routine visits take time. And when problems do arise, the technicians cannot see what has actually happened until they are on site. To rectify a problem, they sometimes have to call for help from other experts.

This is what Waterschap Hollandse Delta wanted to change. “To ensure maximum possible plant availability and reduce costs, the authority looked around for a partner who could provide an intelligent maintenance scheme along with a comprehensive service package for the next 10 years,” reports Julia Grether. Endress+Hauser sold the water authority on an all-round portfolio of measuring technology, coupled with the possibilities offered by the Netilion IIoT ecosystem. “What helps us is the capability for continuous remote monitoring of the instrumentation. Plus, over time, we can leverage the data to become proactive and stop problems before they even occur. Our goal is a significant reduction in the number of on-site service calls,” says Julia Grether.

*“The smart maintenance management feature helps customers to fully concentrate on their core competencies.”*

**Julia Grether,**  
IIoT Product Owner at Endress+Hauser

- 1 One of 19 wastewater treatment plants operated by the Waterschap Hollandse Delta water authority.
- 2 Sensor data and device information are remotely accessible via digital services.



# 20 – 40%

savings potential in maintenance costs and up to 50% less plant downtime are what consulting firm McKinsey sees resulting from predictive maintenance.

## INCREASED OPERATIONAL RELIABILITY

How, exactly, does this work? First, existing instrumentation was completely swapped out. The newly installed sensors and analyzers from Endress+Hauser all send their signals and data via edge devices to the Netilion cloud. The Netilion Health service in turn gives the Endress+Hauser team a dashboard they can check anytime to see that everything is okay, based on the constant monitoring of the instruments' diagnostic data. Should an error pop up, technicians use the transmitted diagnostic information to instantly pinpoint the cause and decide how to fix things. "Netilion Analytics also shows the precise location of each instrument in the plant," adds Julia Grether. Finally, the Netilion Library service helps on site by presenting full documentation for any instrument.

But Netilion does more than facilitate a fast and focused response to malfunctions. It also helps to prevent them from happening at all. "Our analyzers detect supply levels of reagents needed for operation," explains Julia Grether. Should a supply fall below its predetermined threshold, this automatically triggers a notification. The water authority can then act in time to top up the supply and ensure continued reliable operation. "Netilion also makes it possible to keep an eye on the sensors. If we detect deviations over time, we can replace them before they malfunction," says Julia Grether. According to the contract, Endress+Hauser assumes full responsibility for maintenance and calibration activities during the first year. Thereafter, appropriately trained authority employees will use Netilion themselves for basic service activities such as sensor cleaning. "The smart maintenance management feature helps customers to fully concentrate on their core competencies," points out Julia Grether.

*“Compatibility between systems is essential for plant operators to extract optimum benefit from field-level data.”*

Steffen Ochsenreither,  
Business Development Manager at Endress+Hauser



## LINKING SYSTEMS

“We have talked about condition monitoring and predictive maintenance in the process industry for ages. Now we are gradually approaching these topics,” says Steffen Ochsenreither, Business Development Manager at Endress+Hauser. However, large brownfield plants often contain not just hundreds but thousands of sensors from various vendors. “Compatibility between systems is essential for plant operators to extract optimum benefit from field-level data,” explains Ochsenreither, who adds: “This is why our Netilion IIoT ecosystem offers connectivity with other cloud solutions.” One example is SAP’s Asset Intelligence Network (AIN), a cloud-based maintenance platform giving shared access to operators, suppliers and service partners. The prerequisites are defined interfaces and a standardized reference architecture that ensures all manufacturers adopt the same structure for providing data and information.

Both pharmaceutical company Boehringer Ingelheim and the Crop Science division of chemical and pharmaceutical giant Bayer use SAP AIN to administer their field instruments’ master data and manage maintenance and calibration activities. This all helps to optimize plant upkeep. “There is an interface for providing instrument-specific data and information from the Netilion cloud to the SAP AIN platform,” explains Steffen Ochsenreither. “Employees have ready access to up-to-date information and documentation on every field instrument, so they can complete tasks faster without needing to access manufacturer-specific solutions and platforms,” says Ochsenreither, clarifying the advantages. He sees this as a first step toward more transparency and even deeper integration. “Connectivity between IT systems like SAP and production processes at the OT level opens up completely new digitalization potential,” adds Ochsenreither with confidence. “This allows optimization of operational processes over a plant’s entire life cycle, as well as linking of value chains beyond enterprise boundaries.”

1

1 Large chemical and pharmaceutical plants are fitted with thousands of sensors from various manufacturers.

2 The Netilion IIoT ecosystem includes interfaces for providing instrument data and information to other platforms such as SAP.



2

# Doing more with data

Data is changing our world. Endress+Hauser, too, intelligently draws on this resource – and thus time and again delivers the key differential.

## “Uncorking the data bottle”

Many companies in the process industry are sitting on a treasure trove of data. Endress+Hauser is on a mission to help customers make more out of it. “The potential is huge,” says Marco Colucci, who in his role as digitalization expert at Endress+Hauser is closely positioned to help usher in this change.

Questions: Kirsten Wörnle  
Photography: Andreas Zimmermann

### INNOVATION

**Digitalization in the process industry holds the promise of more transparent business processes – and hence new insights. How far along are your customers and where does Endress+Hauser play a role?**

We want our customers to make better decisions – data-based decisions – armed with valuable insights about their processes. Combined, customers’ plants contain millions of Endress+Hauser instruments, most of which can communicate digitally. Our intelligent sensors supply extensive diagnostic and monitoring parameters. Their data is a source of wide-ranging insights that in turn expose new optimization opportunities. And yet, customers currently use less than three percent of the data from our field instruments.

#### Why is that?

Older plants often lack the digital infrastructure needed to tap into and transmit the device data. The instruments themselves are intelligent, yet one might say that the cork is still stuck in the data bottle. It also comes down to the issue of knowledge and what you can do with the data. And this is where our digital services come in.

#### Where do solutions from Endress+Hauser come into play?

First, we handle the seamless transmission of process and device data from the field, for example using the latest Ethernet and wireless communications technologies. Then our data scientists, with their instrument and application knowledge, use the accumulated data and associated context information to develop



### MARCO COLUCCI

Marco Colucci (52) heads up Digital Strategy & Portfolio at Endress+Hauser Flow in Reinach. Originally an electronics engineer, during his MBA training he began to engage with the opportunities that digitalization brings.

digital applications. Depending on the process or the customer’s preference, these digital applications may run locally on edge computing devices or via Netilion, our cloud-based ecosystem for the Industrial Internet of Things. They can also be integrated into other digital ecosystems, such as the customer’s own system. These are all out-of-the-box solutions, ready for immediate use. Unlike big data applications, they do not require months of collecting and analyzing large volumes of data.

#### Where are your applications at work?

One example is Netilion Water Network Insights, a cloud-based system that we developed for monitoring complex water grids. For instance, heavy rainfall warnings or consumption forecasts can be integrated into this solution with the help of artificial intelligence. Moreover, our measurement instruments with Heartbeat Technology continuously send information about their condition. From that, an algorithm is able to determine the optimal moment for maintenance or calibration. This

increases product quality, provides safety, leads to more efficient maintenance and minimizes plant downtime. Another promising area is inline process and quality control, which brings us to the field of soft sensors.

#### What exactly are soft sensors?

They are a kind of virtual sensor: applications with an AI component that, for example, combine various measurement parameters with process and context information to generate a new measurement or target parameter that cannot be determined using a physical sensor alone. This is interesting for the food industry, say. To date, the manufacturing process has to be interrupted so that a human inspector can test the taste and consistency of cream cheese or yogurt products. A soft sensor is able to replicate these human senses and supply the same result, all while the process continues to run.

#### Who owns this data and does this ultimately mean that you develop individualized apps?

It’s the customer’s data, yet we learn from it. We aim to utilize the accrued process knowledge in a scalable manner to further improve our products and develop new solutions. One thing of growing future importance is the establishment of innovation relationships between us, our customers and value creation partners. Digitalization only works really well in networks.

# The patterns of the world

Rebecca Page works as a data scientist at Endress+Hauser. Armed with a wealth of data, she gains new insights that plant operators can use to optimize processes and make better decisions.

Text: Kirsten Wörnle  
Photography: Andreas Mader



*“I’ve got one eye on the user, the other on the science.”*

**Rebecca Page,**  
Expert Data Scientist

“I’ve got one eye on the user, the other on the science,” says Rebecca Page, an environmental engineer who got her feet wet in data science while working toward her doctorate. Along with technical and logical understanding of matters, working in the field calls for abstract thinking skills and a healthy dose of tenacity. The data engineering alone (preparing data sets) can take days. “If the data isn’t valid, then neither are the insights we derive from it,” she explains. That in turn makes it impossible to train the algorithms designed to automatically spot anomalies later on. Describing interrelationships in a way that can be translated into scalable program code is the main challenge.

“Machine learning isn’t a magic potion that solves every problem,” Rebecca Page says. At the same time, it is a tool that creates new benefits along the entire value chain. And it is fueling the growth of the Endress+Hauser community for artificial intelligence where the data scientist is a considerable driving force. People from many different departments and business units are working hand in hand. What unites them is a mind for processes and a nose for how things are connected. It’s a job that inspires Rebecca Page day in, day out – and one that has found its way into her personal life as well: “When you’re out and about in the world, you suddenly start to see the patterns everywhere.”

**DATA SCIENCE** The asphalt glistens as Dr Rebecca Page makes her morning commute into the office. A summer thunderstorm has broken the heat of the past few days. The Birs – a river near Endress+Hauser headquarters in Reinach, Switzerland – is surging, its waters muddy. For most, the rain and its effects are nothing more than mere weather. For the data scientist, though, they are a sign: river water contaminated with microbes could seep into the groundwater catchments and pollute the supply of drinking water. Specialists from the municipal water company will have to go out and take samples. Rebecca Page has been working on an early-warning system for situations just like this. The system, once ready to use, will be capable of predicting which reservoirs and wells are at risk of contamination and sending a timely alert to the authorities.

Making forecasts with measurements and mathematics instead of samples and laboratories is the task Rebecca Page dedicates herself to every day. The expert data scientist examines a wide range of measurement, flow and simulation data to find out how everything is interrelated. That data will later be used in the early-warning system. She is also working on a way to measure the quality of a dairy product without sampling it, as well as a method to dose expensive flocculants into dewatering systems with the precision it takes to extract as much valuable metal as possible from silt and mud without clogging anything.

“I’m always fascinated by how you can derive something new from various physical measurements and other information,” Rebecca Page says. An expert in her field, she draws on raw, measurement and process data. She also must consider the context, such as the season, or the day of the week. For dairy products, she even has to take into account whether the cows were put out to pasture or kept in a barn.

## IIoT

Fermentation is a key process in brewing, not to mention one of the most dynamic. In a fermentation tank, yeast produces alcohol from the sugars in the wort, along with carbon dioxide and a variety of aromas that together give the beer its fizz and flavor. Brewers must keep a close eye on the process to ensure that everything works as it should. They regularly monitor parameters such as residual extract, alcohol content and the degree of fermentation by taking samples, checking density using a hydrometer or laboratory analysis.

The new QWX43 fermentation monitor from Endress+Hauser makes all this effort a thing of the past. The system provides precision measurements of four parameters from directly inside the fermentation tank. The QWX43 uploads its data straight to Netilion, the Endress+Hauser cloud-based IIoT ecosystem, where an algorithm calculates all of the relevant fermentation parameters and enables real-time fermentation monitoring. “We developed a multi-sensor system and combined it with IIoT technology,” says product manager Julia Rosenheim. “Only then could we realize easy-to-use inline monitoring, accessible from anywhere.”

The fermentation monitor keeps the process under complete control without the brewers needing to be on site. And that’s not all: brewers can set alarms for each distinct stage of fermentation for different types of beer. They can even use a perfectly brewed batch as a reference. The system will then notify the brewers should the fermentation process deviate from the reference values. “Our system puts data in the brewers’ hands to optimize their fermentation process,” Rosenheim adds. “Now they can be certain that all their beer tastes just as good – exactly how their customers expect it to taste.”

# The taste of digitalization

**Brewing beer with the help of an algorithm: a new multi-sensor system models the fermentation process in real time. The live feed from inside the tank is made possible by a combination of various measurement methods with IIoT technology.**

Text: Christine Böhringer  
Graphics: 3st

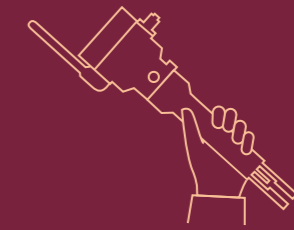

## A LOOK INTO THE FERMENTATION PROCESS

1

Monitoring the fermentation process is all about taking measurements, and that’s exactly where the QWX43 fermentation monitor comes in. It is operable inside a range of tank systems and does not require adjustment or calibration.

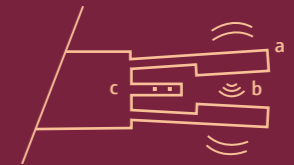

2

The multi-sensor is immersed directly in the beer. The system then uses two tuning fork sensors (a), an ultrasonic pulse generated by them (b) and a temperature sensor (c) to continuously monitor four parameters: density, acoustic velocity, temperature and viscosity.



3

The QWX43 contains a web server that securely connects to the user’s wireless network and sends all its measurements to Netilion, the Endress+Hauser cloud-based IIoT ecosystem. There, an algorithm calculates a comprehensive set of fermentation parameters, such as wort density, residual hop extract, alcohol content and degree of fermentation.



4

The Netilion Value digital service enables brewers to access the data from anywhere. Alarms can also be set.



5

The more data the better: Netilion Value also allows brewers to compare values against previous fermentation batches for data-driven process optimization.



1 Smart measurement technology uses sensor signals for new diagnostic, testing and monitoring functions.

2 Plant operators gain deep insights into the device and the process – and can thus increase productivity.



1

# Clear signals

Field devices with Heartbeat Technology have a sense of what's going on: they intelligently use sensor data in addition to the primary measured value to provide deep insights into the instrument and the process being monitored. The benefits are huge – even predictive maintenance becomes possible.

Text: Christine Böhringer  
Photography: Christoph Fein  
Graphics: 3st



2

### SMART SENSORS

A shutdown of a production plant is always costly – especially if it's unplanned. According to a study conducted by AI specialist Senseye, large industrial plants lose on average 323 hours of production time annually. Average losses caused by downtime amount to 170 million dollars per plant. So it's no wonder that three out of four companies have declared predictive maintenance as a strategic goal.

The question is, how can a plant operator know early enough that a process is not running smoothly or that there is an issue with an asset? “This is why Endress+Hauser developed Heartbeat Technology,” explains Daniel Persson, Process & Portfolio Manager for Innovation. It is built into numerous measuring instruments for flow, level, pressure and temperature, as well as for liquid and gas analysis. “With Heartbeat Technology, field instruments monitor themselves and even spot changes in the process. This allows for reliable detection of anomalies and timely implementation of corrective measures,” says Daniel Persson.

Heartbeat Technology is based on signals that field devices capture in addition to the primary measured value. “We use these signals for various functions that are integrated directly into the device and provide plant operators with practical added value,” reports Daniel Persson. All those functions provide detailed insights about the instrument and the process, which help to increase plant availability and reduce operating costs. With the Heartbeat Diagnostics function, for example, instruments continuously check themselves in the background and report their status. In the event of instrument failure or disturbed process conditions, they provide clear information on what is happening right now and what needs to be done next.

With Heartbeat Verification, instrument performance can be verified at the push of a button without interrupting the process. Among other things, it automatically tests whether device components still retain their original reference values and indicates the presence of specific system faults that might impair instrument or process performance. The verification concept is traceable in compliance with ISO 9001 and certified by an external authority. “Self-diagnostics and verification improve process performance, as well as enabling optimization of calibration and test intervals,” says Daniel Persson.

### LOOKING FOR PROCESS TRENDS

Even more can be derived from sensor signals, for example whether demanding process conditions are adversely affecting the instrument. “Typical examples include corrosion or abrasion of the sensor components, the appearance of foam in a tank or build-up on the sensor surface. Heartbeat Monitoring functions detect these factors and convert them into easily understandable information about the instrument and the process,” explains Daniel Persson. By observing these parameters over time, plant operators can reliably and promptly identify undesired deviations.

Most Heartbeat Technology functionalities are accessible from the instrument. However, the full potential is unlocked when field devices are integrated with the plant infrastructure or even connected to the cloud: processes can be optimized or maintenance activities scheduled for a suitable time.

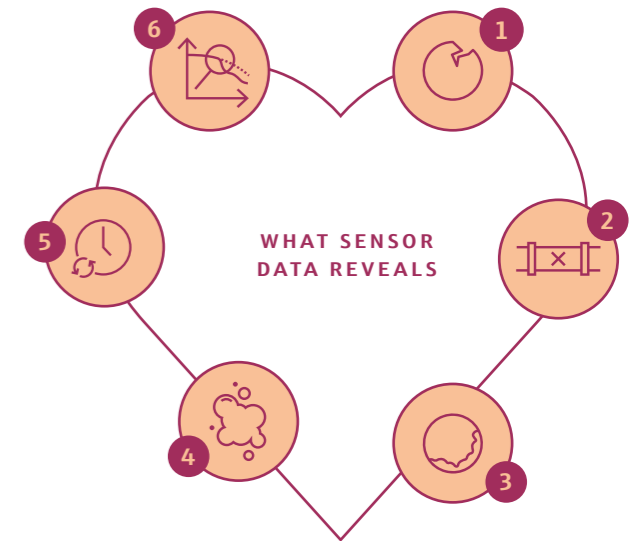

- 1 Coriolis flowmeters detect the presence of corrosion by analyzing the vibration behavior of the measuring tube.
- 2 Deltabar pressure transmitters use sensor noise to detect blocked impulse lines.
- 3 Electromagnetic flowmeters analyze electrical conductivity inside the measuring tube to detect build-up.
- 4 Radar-based level instruments can tell by the echo amplitude whether and how much foam has formed in a tank.
- 5 Radiometric level instruments calculate their optimum replacement time based on the declining strength of the radioactive source.
- 6 Analytical transmitters derive performance indicators that help operators to optimize availability of the measuring point and reduce maintenance work.

**EASIER INTERACTION**

Shopping like Amazon, searching like Google: endress.com is Endress+Hauser's online platform for cooperation with customers. "To continue improving our website, we collect information about users' surfing and purchasing behavior," explains Vincent Dessus, Head of Digital Business Development at Endress+Hauser. The company uses this data to make it easier for customers to find, select and order the right devices for their needs. An algorithm uses initial entries made in the device configuration, along with user location data, to determine the product typically ordered by customers there. Then it automatically fills in the next few fields. There is also a new 'Get quote' feature: "We noticed that although online customers don't expect an individual quote, they do still need an official document," says Vincent Dessus. "Now they can get a PDF quote in seconds."



**SMART PRODUCTION**

Artificial intelligence supports laser welding in pressure transmitter production. "Conventional algorithms don't reliably recognize the welding position," says AI expert Dr Jawad Tayyub from Endress+Hauser Level+Pressure. "That means the people at the welding stations have to check it every time. They often have to make corrections manually, which is monotonous and tiring work." Artificial intelligence immediately increases the correct detection rate to over 98 percent, making work easier and reducing the number of rejects. "We do that using a neural network taken from the medical sector," Tayyub explains. A comparable network helps doctors to detect skin cancer. The raw data is similar in both cases: image analysis largely concerns monochromatic areas that clearly stand out against their surroundings.



**PROACTIVE SERVICE**

What is the long-term performance of measuring instruments in the field? Endress+Hauser introduced a specialized web application several years ago to find out. "An overnight database run condenses every service case worldwide into a single graphic, so we can see at a glance whether there are frequent events with a particular device," explains Enrico De Stasio, Head of Lean Administration. These reports are used to identify the cases in question, since sometimes all that is needed is a routine service. "This lets us service or recall the devices in good time – before our customers experience any issues," De Stasio says. The data also helps with new developments and with detailed understanding of the root causes of instrument damage: "Often, environmental conditions at the installation site are a factor in servicing," adds Thomas Fricke, Head of Marketing Services at Endress+Hauser Temperature+System Products. With this in mind, plans are under way to improve the application by using AI and integrating other sources such as meteorological data.



**OPTIMIZED SHIPPING**

Endress+Hauser does not keep a stock of measurement devices. Given the multitude of variants, almost every instrument is one of a kind and made to order. Many regions handle shipping from a central logistics hub. "At our North American and European hubs, an algorithm ensures that products reach the customer on time. The AI is flexible to find the best logistics service for each delivery based on historical and current data," explains Oliver Blum, Corporate Director of Supply Chain. The algorithm ensures the deliveries are reliable, even in unsettled times: in 2021, 91.2 percent of deliveries in Europe arrived on time.



**TRANSPARENT PURCHASING**

The Endress+Hauser Group has over 50 sales centers. As well as selling products, they increasingly offer solutions and services. This involves sourcing materials, such as mechanical accessories, and expertise from third parties. "To add transparency and structure in this area, an AI application scans through texts from all our SAP systems and assigns the third-party items to merchandise categories. It would take months for humans to analyze and interpret these tables," says Oliver Blum. The AI system was trained by employees, and the sales team is working on enhancing the data quality. "This means we can now pool our purchasing activities and increase quality for customers," Blum adds.



**PROCESS OPTIMIZATION**

# A clear advantage

Endress+Hauser harnesses data and artificial intelligence to optimize internal processes along the value chain. The result is improved transparency, quality and efficiency – for customers, too. Here are five examples.

Text: Christine Böhringer, Manuel Wittek  
Graphics: 3st

Full concentration, together: Netilion developers work on applications in short sprints – always collaborating closely as a team.



# Delivering with agility

**Endress+Hauser is developing the Netilion IIoT ecosystem in small steps. This approach lets users quickly and easily derive benefits from their data – and ensures that the solution fits their needs perfectly.**

Text: Christine Böhringer  
Photography: Christoph Fein

**DIGITALIZATION** An engineer, sitting alone hunched over a desk, working for months on a single concept and then spending just as long meticulously bringing it to fruition: for a long time, that was how software was developed at many companies. “Ultimately, many of these projects failed because they didn’t match up with customers’ needs, or because requirements had changed in the meantime,” says IT expert and software engineer Andreas Hofmann. That’s why he takes a different approach when it comes to expanding the Netilion cloud-based IIoT ecosystem with his team at Endress+Hauser. “We use agile methods like Scrum. That leads to short product launch times – and allows plant operators to reap added benefits from their field device data quickly, without laborious and time-consuming software installations.”

The centerpiece of Netilion is the Netilion Cloud, which is where field device data is sent. Endress+Hauser has built on that solution by providing Netilion services, a collection of specific web-based applications. There are currently six of them, all created through sprints. “For such a sprint, we break down a software application into individual small functionalities designed to add value for the customer, and then we program each of them within two weeks,” Hofmann explains. The developers then present the results to an internal panel of up to 70 people having very close contact with customers from a wide range of industries. To ensure that the products developed by Endress+Hauser are aligned with actual needs, customers themselves sometimes join the panel. “In many small steps, we move closer to creating true customer benefit,” the team leader says, emphasizing how important this kind of flexibility and agility is: “The world is no longer just complex. It’s chaotic. Everything can change in unforeseeable ways at any time.”

Once an application is basically up and running, it is released as soon as possible and further developed with pilot customers. One thing the services share is their easy and intuitive user experience. “Users can get started right away,” Hofmann says. The apps help them to do things like monitor instrument status, organize device-related documents and access measured values from anywhere. Netilion Analytics is a good example of what a huge difference this can make. The service can be used to digitally capture and manage information about the installed base. “Netilion is 70 percent faster than manual data collection,” Hofmann says. Service technicians no longer need to spend days walking around plants. “This is a real success story in terms of boosting efficiency,” he adds.

# The treasure trove

**When Endress+Hauser began building a centralized instrument database 20 years ago, the Internet of Things was still a distant vision. Michael Herzog, a founding father of the Common Equipment Record, explains how it came into existence and why the huge volumes of data are a genuine treasure trove today.**

As told to Christine Böhringer  
Photography: Andreas Mader

**SERVICE** You mean to tell me that Endress+Hauser has been systematically and centrally gathering instrument information for 20 years? I hear this astonished question quite often, because many other companies are only now beginning to establish such databases. We can thank our service orientation for the fact that we are a pioneer in this field. Back then we realized it would be complicated if customers could no longer find a calibration certificate, one of the most important instrument documents. With the serial number in hand, they had to call the responsible sales office, which in turn contacted the respective production facility, where the certificate had to be searched for – and then everything took its return journey to the customer. The archive was already huge at that time, even though back then we were producing only a small fraction of today’s 2.7 million sensors!

The Common Equipment Record allowed us to eliminate the mountain of paper. With the help of interfaces, our own proprietary system and a new standard, we first stored the certificates and then more and more information about the instruments. That information was now available in-house around the world – digitalized and stored in one location – which meant that the sales offices could answer customer inquiries faster. Today the system contains information on more than 50 million instruments: core data such as serial number, production date, documentation, 3D drawings, replacement parts lists, latest software and all the service reports. So, more than just a ‘register of births’. The database reflects the entire lifespan of our measurement instruments. And today it also helps in creating digital twins, for example.

I must admit that 20 years ago, we approached the whole thing very intuitively. But we were confident that the information would create a lot of benefits. Indeed, as time progressed and the volume of data continued growing, it turned out to be a real treasure trove and a vast source of knowledge. For example, it wasn’t long before the



Michael Herzog (63) is an electronics engineer and has worked for Endress+Hauser for more than 38 years. As Director of Quality and Business Excellence, today he makes sure that Endress+Hauser customers are satisfied and receive optimal support.

data was being used to better advise customers and generate new quotations. On top of that, we gave customers access to their own product data on a single platform. With this transparency, we not only built a lot of trust but created new benefits as well. Since then, plant operators have been able to manage their products over the entire life cycle and thus optimize their processes. And today, instrument traceability helps quality management to create a high degree of transparency regarding product quality in the field.

We have now reached a point where we have so much data that we can use new technologies to analyze it and identify patterns. For instance, we can see how an instrument behaves in the field over a long period of time. And all without having to generate additional information, for example via service personnel. This brings us back full circle to the inception of the Common Equipment Record. It will also help us to further improve our quality and our service, in totally novel dimensions. I’m curious to see what else we can gain from our treasure trove of 50 million instruments!

# A virtual friend for life

**A digital twin is the virtual likeness of a real-world object. Underlying that likeness is a wealth of data and algorithms that can be used to simulate aspects such as installation and functioning. But Endress+Hauser's vision goes further: the goal of a digital twin is to offer added value for customers across a product's entire life cycle.**

Text: Richard Backhaus  
Illustration: 3st

Up until just a few years ago, customers selecting components for their plants had little choice but to pore over thick catalogs, extract huge volumes of technical data from tables and compare documentation supplied in varying formats. When it came to operation, documents for certification and testing, maintenance and security checks were produced, updated and filed by hand. It was a labor-intensive and time-consuming process. Now, with the digital twin approach, Endress+Hauser is moving all of that into the virtual world. "By doing this, we simplify handling for customers and increase efficiency across a product's entire life span, from selection, ordering and commissioning to service and maintenance and through to replacement," explains Franz Durmeier, a marketing expert for Endress+Hauser's digital portfolio.

Early on when planning a new plant, customers will select the right sensor from Endress+Hauser in a simple, convenient process using an online configuration tool where they can enter their requirements and use the digital twin to simulate installation and functioning. Then, when the order is placed, product information such as type and model number will be communicated in a format that is readable by the customers' enterprise

management software. Electronic guides and specifications accessible online from anywhere in the world will make it easier to install, calibrate and commission the measuring instrument. Certificates and checklists provided automatically will accelerate technical acceptance and testing procedures, since all of the documents needed will have been prepared in compliance with standards and will be readily available for inspection. During the service and maintenance phase, dynamically updated digital service schedules will support life cycle management for the device. Service needs will be flagged early on and maintenance can be assigned automatically. This will ensure a long life span and minimizes risk of instrument downtime. When a sensor is nearing the end of its life, customers will be offered the replacement that meets their needs.

To create the digital twin, Endress+Hauser's IT systems translate all of the information relating to the specific measuring instrument – design data, guides, certificates, other technical documentation – into data sets that easily slot in to the customer's digital ecosystem. Depending on the customer's preference, the IT structure can also encompass the Netilion cloud from Endress+Hauser or another cloud solution. "The advantage of our cloud is that its configuration is aligned to the process industry. It offers direct access to all product documents, so customers can benefit from a digital twin without investing a lot of time and effort," explains Kevin Rueff, Digitalization Product Manager at Endress+Hauser.

To ensure smooth integration into other cloud and IT systems, Endress+Hauser participates with other companies and industry associations in international committees working on standardizing data interfaces. The goal is to establish a software structure with what is known as an asset administration shell: a standardized, universal container that can be filled with as much information as required. "Hence we have the foundation for smart systems that can be seamlessly integrated into concepts such as Industry 4.0," says Durmeier. This also includes constantly updating and expanding data sets for the digital twin. His takeaway? "We've seen that customers' requirements are constantly evolving. The digital twin will always be a work in progress."

Thinking in generations, not quarters. Every day the family company Endress+Hauser works to change something for the better with innovative ideas, dedicated employees and sustainable action.

Text: Christine Böhringer, Kirsten Wörnle  
Photography and Graphics: Endress+Hauser, Christoph Fein, Kristoff Meller, Shutterstock, 3st

# Full speed ahead



7

This is where Endress+Hauser ranks among Switzerland's most innovative companies.

360

innovators were involved in a patent filing in 2021.

> 8,600

patents and patent filings are in the Endress+Hauser intellectual property portfolio.

764

patents were granted worldwide to Endress+Hauser in 2021 – a new record.

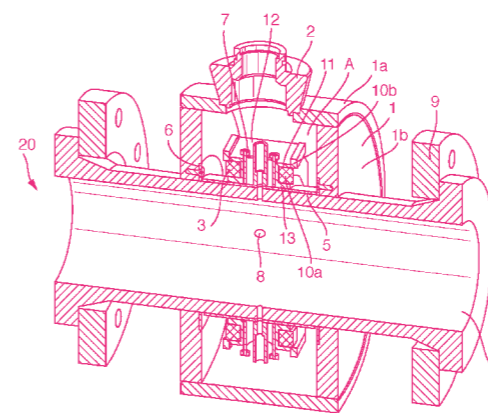

## A culture of innovation excellence

An abundance of particularly good ideas originate from Switzerland. According to the Global Innovation Index, Switzerland has the world's most innovative economy, followed by Sweden and the US. And what about Endress+Hauser? It's among the country's top performers. A 2022 ranking published by Statista, a statistics and data service provider, says the Group is one of the top 10 most innovative companies in Switzerland – and is even at the top of the list within its own industry.

"Innovation is a driver of our growth, which is why we actively promote it within the company," explains Chief Operating Officer Dr Andreas Mayr. Around 7.5 percent of sales revenue is earmarked for research and development, with close to 1,200 people at work in this area. The company operates a program that encourages every employee to report innovations. Further underscoring the culture of innovation fostered by Endress+Hauser is the annual Innovators' Meeting, an event that provides an opportunity for the Group to honor creativity and dedication among its innovators while offering a venue for them to meet and network. Recognition is given not only to economically important patents and highly creative innovators. There are also awards for process improvements and for finding new ways to use previously developed solutions.

*"Many ideas arise when people meet by chance and share information with one another. It's simple: together we are more creative and innovative."*

Dr Andreas Mayr, Chief Operating Officer of the Endress+Hauser Group

## Success in tandem



Networking and promoting women so that they comprise 40 percent of the Endress+Hauser workforce by 2030 and represent one-third of management: such is the goal of the Women's Integrated Network (WIN) initiative at Endress+Hauser. In the US, where WIN was launched in 2015, the proportion of women has risen from 22 to 30 percent. Furthermore, the proportion of female managers has more than doubled from 14 to 30 percent. All of this was achieved by focusing on areas such as talent acquisition, career development, networking and a recently established mentoring program. Spurred by this success, Endress+Hauser subsidiaries in the US set themselves a new objective: increasing the proportion of women, managers included, to 40 percent. The US is exemplary when it comes to effectiveness of the measures, which in turn provides a boost for the WIN initiative at subsidiaries in other countries.

## Green alliance

Green hydrogen, that is to say hydrogen generated using power from renewable energy, is viewed as the key to decarbonization in a wide range of sectors – and also as a core element of the energy transition. With this in mind, Endress+Hauser joined the European Clean Hydrogen Alliance. This EU initiative is driving the development of a clean and competitive hydrogen economy in Europe with the aim of achieving climate neutrality by 2050. Endress+Hauser already boasts a broad portfolio of products designed for critical process measuring points in the production, storage and utilization of hydrogen.



## Abuzz with sustainability

Endress+Hauser Flow has welcomed around 30,000 new employees to its headquarters in Reinach, Switzerland. Two full-grown bee colonies were relocated to the roof of the product center for flow measurement technology, where they are being tended to by a hobby beekeeper who works for the company. As well as producing honey, the insects are playing a role in climate protection. It's only through their pollination activities that ecosystems can function, which in turn helps plants to capture carbon dioxide. That particular suggestion originated from the recently established Endress+Hauser Flow sustainability network. Employees across all departments develop ideas for greater sustainability in areas such as mobility, the campus, the circular economy, nutrition and products.

## Digital assistance for salmon

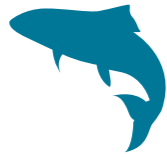

Until something like a century ago, the Rhine was home to the largest population of salmon in Europe. Overfishing, water pollution and the construction of dams subsequently caused this species to disappear. Efforts have been underway since the 90s to reintroduce salmon to the Rhine, not least through targeted repopulation. Helping the overall effort is a digital water monitoring solution from Endress+Hauser France, installed at a fish farm in the Petite Camargue Alsacienne nature reserve in the Upper Rhine region of France. More than 300,000 eggs are incubated there every year thanks to a dedicated breeding platform operating with recirculated water, after which the young Atlantic salmon are released. The farm operators can use the IIoT-based solution around the clock to check whether tank conditions are optimal for the salmon. Endress+Hauser sensors measure and analyze all the crucial parameters. Measurement and status data from the instruments is transmitted wirelessly to the Netilion cloud. The Netilion Value service facilitates remote access and raises alarms should threshold values be exceeded, or in the event of a malfunction.



## Sewage as an early warning system

In 2020 Endress+Hauser subsidiary Analytik Jena had already developed a complete PCR-based solution able to detect the presence of coronavirus in wastewater within just a few hours. A study has now shown that the process is fast and reliable at mapping the spread of the virus, thus making it a suitable means for tracking the development of the pandemic. This prompted Analytik Jena to join forces with Bauhaus University in Weimar in the German federal province of Thuringia to analyze the wastewater in 23 treatment plants over several months. "We discovered that data from wastewater analysis generally predicted coronavirus incidence rates several days ahead. The same data also showed the transition from one Covid wave to the next," says Dr Robert Möller, Project Manager at Analytik Jena. Furthermore, when fewer people were tested for coronavirus, hence reducing the number of reported cases, the incidence in wastewater remained high or even increased. Since every infected person excretes virus residues, the true dynamic of the pandemic can be tracked through wastewater, independent of testing rates.



"In March we took in three mothers and their five children for several months. Two families came to us via the local aid center and one family of a friend of ours arrived directly from a war zone in southeast Ukraine. The first days were difficult. The families arrived with hand luggage only. Although we had to organize things ourselves, we received help from the local authorities and neighbors. I was impressed by how quickly all of them managed to settle in to a foreign country. The children were going to school or daycare centers within a few weeks. Many of the mothers had at least temporary jobs after a couple of months. One of the young girls is still living with us. She plans to study mathematics in Poland."

**Janusz Zajączkowski, Industry Manager Power & Energy, Endress+Hauser Poland**

## "We wanted to act"

The Ukraine conflict elicited a great willingness to help within Endress+Hauser, with many employees committing to helping refugees privately. Below is a sample of what they have experienced.



"As the war began it was clear to me that I wanted to help. I'm originally from Kazakhstan and my grandparents were born in Ukraine. A friend from a church association organized the transport of food aid to Poland where many Ukrainians had fled. Since I speak Russian, I went along on the 1,400 kilometer journey as an interpreter. On the return trip we took refugees with us – a very emotional experience. We arranged accommodation for them at our destination in Germany. It was heartwarming to see how much willingness there was to help wherever we went. What was the takeaway for me? We can if we want to; together we can unleash powerful aid and assistance – and suffering elicits any amount of humane responses in people!"

**Daniel Ens, Global Lean Driver, Endress+Hauser Group Services Switzerland**

> €40,000

was collected by employees in the first half of 2022 as part of the Endress+Hauser Water Challenge. The goal of this initiative is to give people access to clean water. Challenge participants undertake a physical activity like jogging or cycling and donate an amount of money that is then doubled by a matching contribution from the company. Endress+Hauser Germany was especially active, cycling more than 37,000 kilometers for the benefit of a cistern in Tanzania. Projects in India and Cameroon were also supported.

"Right at the beginning of the war, we created a channel on MS Teams for Endress+Hauser Poland, where we exchanged information about how to help refugees. One day the question was asked whether anyone could host people from Ukraine. I answered that my family and I could offer one room. My wife and I are parents ourselves and couldn't bear the thought of women with children spending nights at train stations or in emergency shelters – we wanted to act. So for two months we lived with two young mothers and their children. Everything worked out well. Today, our guests all live back in Ukraine, in safety, together with their families. We continue to stay in contact. Despite many adversities, they are confident that the future will be better than what they are experiencing now."



**Maciej Turkiewicz, Sales Director, Endress+Hauser Poland**

# Simulate, then build



**Nearly every Endress+Hauser instrument is developed with the help of computer simulation. That not only leads to outstanding product characteristics but also takes the innovation process to a new level.**

Text: Kirsten Wörnle  
Photography: Andreas Zimmermann

## DEVELOPMENT

Take a typical application in the water or food industry: flow needs measuring at a specific place in the plant, but there is a bend in the pipe just upstream or downstream of the measuring point. The liquid develops vortices and turbulence, and hence doesn't flow smoothly through the instrument as the sensor expects. This throws measurement results out of kilter.

For a long time, to deal with such flow disturbances plant operators had to either adhere to the recommended inlet and outlet distances or deploy an instrument with a restricted measuring tube. Since 2020 Endress+Hauser has offered an instrument that supplies precise measurements independent of the inlet conditions. The Promag W, with the  $0 \times DN$  full bore option, is the world's first electromagnetic flowmeter that consistently supplies correct measurement values regardless of the flow profile. The instrument was developed with the help of numerical simulation.

## THOUSANDS OF VIRTUAL PROTOTYPES

Numerical simulation is about modeling a measurement using numbers within a computer, and then testing the model under a variety of parameters. "With this method we are pushing into innovative product development territory that once seemed unreachable and which can no longer be done by conventional means," says Dr Wolfgang Drahm, who heads up a 20-person team of preliminary and fundamental developers at Endress+Hauser Flow. With this approach, the computer model is only representative of the specific problem being addressed – never the whole instrument itself. "Flow simulation requires a different model compared to when you are calculating an instrument's vibration or magnetic properties," explains Wolfgang Drahm.

With the model created, you can then simulate countless designs and potential problems. How do different tube diameters affect the flow? What are the impacts of pressure rating, viscosity of the medium or disruptors such as a 90-degree pipe bend immediately upstream of the instrument? "We know how an instrument will behave even before it takes physical shape," says Dr Vivek Kumar, who champions the topic of simulation within Endress+Hauser as principal expert on the subject. The wealth of parameters in today's process industry is no longer capturable using simple paper, pencil and equations.

Instead, computers run through thousands of virtual prototypes before the first physical instrument is

## USING SIMULATIONS IN INSTRUMENT DEVELOPMENT

At Endress+Hauser, simulation techniques are built in all along the development chain. Early-stage development also benefits from simulation-supported fundamental decisions. In this case developers no longer have to bring in technical experts. Endress+Hauser promotes this 'democratization of digital engineering' across all locations with training programs, a knowledge community and infrastructure to match.

built. "We can use simulations to advance instrument designs to the point where the instruments are increasingly robust against disturbances," explains the fluid mechanics specialist. That was the case for the Promag W with no inlet and outlet runs. "That such a device is even possible stretched our imagination," adds Wolfgang Drahm. Indeed, the optimal solution lay within a very narrow window. "We were able to pinpoint this unique zone aided by the computer, which tested everything in accordance with ideas and specifications from the development team."

## MAN INSTRUCTS MACHINE

Virtual developments such as these are made possible by growth in computing power, increasingly user-friendly software and surrogate models. The latter augment the numerical simulation with the help of mathematical correlations and machine learning. "Whereas in fluid mechanics we can run hundreds of numerical simulations over the weekend, we can optimize yet thousands more designs automatically using surrogate models."

"Many of our innovations would not be possible without the close symbiosis between simulation and experiment," emphasizes Dr Alfred Rieder, who heads up a unit at Endress+Hauser Flow tasked with the fundamental development of Coriolis flowmeters. Simulation provides the development engineers with breathing space to perform their actual tasks. "We can fully dedicate ourselves to the physical issues while the computer calculates the scenarios," says the expert. And this is exactly where the human factor is needed. "Computer simulation is not difficult. What's difficult is teaching the computer what a good instrument is." Only when the human precisely understands and specifies the important factors can the machine do its job properly.



# “The family has to play an active role”

A generational change lies ahead for the Endress family. How does this growing circle of shareholders plan to shape the company in future? And how can the younger generation grow into its responsibilities? Sandra Genge, the latest addition to the Supervisory Board, and CEO Matthias Altendorf discuss the issue.

Questions: Martin Raab  
Photography: Andreas Mader

## REPRESENTING THE YOUNGER GENERATION

Sandra Genge has been a member of the Endress+Hauser Group Supervisory Board since 2022. Beginning in 2006 she represented the younger generation on the Family Council, which serves as a link between the shareholder family and the company. Genge studied communications sciences and is a federally certified marketing and communications manager in Switzerland. She currently works freelance as a design and communications consultant. For the company founder's granddaughter, hosting the Endress+Hauser 60th anniversary celebration in Basel was a defining experience: "When I looked out and saw the faces of 5,000 employees, I realized just how much of a responsibility we bear as the shareholder family and that we have to do everything in our power to live up to this responsibility." Genge (born in 1977) is the mother of three children. In her free time she enjoys jogging outdoors. Since her childhood, traveling – at first with her grandfather, today with her own family – has been a source of inspiration and relaxation. "Traveling opens the mind and the heart. It teaches us to respect other people, cultures and religions. To paraphrase Mark Twain: 'One must travel, to learn.'"

**The coronavirus pandemic is not yet over, and already the war in Ukraine is generating the next crisis. Has this overshadowed your start as a member of the Supervisory Board, Ms Genge?**

**Genge:** Personally speaking, both events are giving me major pause for thought. They show us just how fragile our world is. Which is something we, the post-war generations, are unaccustomed to: we enjoyed a very sheltered upbringing. However, the coronavirus pandemic and the war in Ukraine are not overshadowing my start. On the contrary: the Supervisory Board has debated difficult and important questions. We are demonstrating what we, as a family business, are capable of doing differently compared to other companies.

**Namely?**

**Genge:** As a family business, our focus is not on short-term economic success. We value sustainable, long-term success that serves all stakeholders – including our employees, customers and business partners. We face up to our responsibilities, even through difficult times.



**Altendorf:** Because we maintain solid finances in good times as well, Endress+Hauser has a sound foundation. Our business is widely diversified among regions and industries; we are not dependent on any one market. We pursue long-term goals and share strong values. We have customers who rely on our support and employees who are dedicated to our common goals. And we have shareholders who trust in us to achieve the best results for Endress+Hauser even in difficult situations.

**Ms Genge, you represent the interests of the shareholder family on the Supervisory Board. What are these interests?**

**Genge:** I can sum it up very succinctly: the Endress family’s primary interest lies in Endress+Hauser continuing as a successful family business. Hence, the entire family including me places great importance on the company’s values and culture – the Spirit of Endress+Hauser. That Spirit is a differentiating factor and contributes to our success. My task is to ensure that important decisions align with these values.

**The family is growing, and the second generation is increasingly stepping back. What challenges does this create?**

**Altendorf:** Up until now, the second generation has been a major influence. Four sons and one daughter of Alice and Georg H Endress have worked for the company. Klaus Endress was the Group CEO for many years. Today, he is president of both the Supervisory Board and the Family Council. Urs Endress continues to serve as an ambassador. Of the third generation, only Steven Endress – who manages our business in the United Kingdom – is actively involved. And Sandra Genge, likewise a granddaughter of our company founder, has recently joined the Supervisory Board. We now have to work toward ensuring that more family members develop long-term involvement with the company.

**Genge:** The fewer family members who work on an operative level, the more our direct involvement declines. That brings on challenges in communication between the family and the company, and in transferring business expertise.

**Expertise in the sense of insights, information and understanding?**

**Genge:** Exactly. The company’s professionalism has vastly increased over time. As a growing family of business owners, we too must become more professional. That’s something the family has come to realize. It’s why we created the family charter in 2006, with its principles, rules and institutions. They enable precisely this exchange and flow of information. The charter is a key element for remaining a successful family business.

**What is necessary for the continued existence of the family business?**

**Genge:** From the family’s point of view, it is important that members continue playing an active role in the company. By that I mean more than just involvement in the traditional sense, or operative responsibility. We have various committees, institutions and other opportunities for family members to contribute. Such involvement reinforces the family’s identification and connection with the company. Moreover, we as a family have to demonstrate good community spirit, and we need consensus to keep discord and disputes out of the company.



*“The entire family including me places great importance on the company’s values and culture – the Spirit of Endress+Hauser. That Spirit contributes to our success.”*

**Sandra Genge,**  
Supervisory Board member at the Endress+Hauser Group



*“We have to find people for the Executive Board, Supervisory Board and management who share the family’s entrepreneurial spirit and values.”*

**Matthias Altendorf,**  
CEO of the Endress+Hauser Group

**Altendorf:** The family contributes values, warmth, knowledge and experience – as well as capital. That is why financial success is the fundamental prerequisite for continued existence of the company. The shareholder family also provides stability. Security, reliability and solidarity are invaluable, especially in a highly creative and innovative environment. These have been important elements of our success over the past 70 years and will remain so going forward. There is more to Endress+Hauser than just assets, buildings and machinery. A company is always a social system.

**The family charter states that the shareholder family intends to “continue to shape the company”. How is this done?**

**Genge:** By having family members work for the company, for example. We formulated that as one of the goals in our family charter. For a number of years now, family members have been able to work at every level within Endress+Hauser, according to their suitability and skills. We have precisely defined how family members must be qualified in order to hold senior positions. Not least to protect the company itself, we want to select only the most suitable people.



**Altendorf:** Our founder shaped the company through his personality and leadership style – and through his choice of people. The second generation did the same. Today, the family’s involvement is more strongly institutionalized. However, the family and the company are in constant communication, and family members regularly confer among themselves. Besides the Supervisory Board, where Klaus Endress and Sandra Genge represent the family, there is also a Family Council, the General Meeting of the shareholders and the Family General Meeting. The family exercises its influence through the strategic decisions it makes and through selecting the people who manage the company. The family also has a presence at many occasions and celebrations. Thus it demonstrates cohesion, connection with the company and pride in what the company and the family have jointly achieved.

**What are you doing to recruit young family members to work at the company?**

**Genge:** We are specifically working to guide the younger generation into the company. For all family members aged between 16 and 35, we have the Family Camp. The program is a blend of education and an informal atmosphere where they can interact. We tour the production and sales companies, visit customers and see our products in use. Sometimes, we even take a hands-on approach: once, we drove around Switzerland in minibuses and measured the water quality of the river Rhine at various locations.

**Altendorf:** At the Family Day, we also attempt to gather all of the family members together so that they can grow better acquainted and join in a shared experience. Being a company owner can be a real pleasure. But it is also a responsibility, since ownership brings obligations. We have to reduce the burden of this responsibility somewhat and shift the focus to the benefits and community spirit. By working at the company, we can achieve something that is bigger than ourselves. That goes for employees and family members alike. If we can awaken this sense of delight, then I am certain that we will be able to inspire subsequent generations as well!

**And what if that does not succeed?**

**Genge:** That is not an option!

**Altendorf:** Currently, no family members are represented in the Group’s operative management. Among the third generation, however, we have numerous people with interest or actual involvement in the company. Phases like this will always occur. That is why we have to find people for the Executive Board, Supervisory Board and management who share the family’s entrepreneurial spirit and values and exemplify all of this in daily life. Furthermore, the family has to play a decisive role at critical junctures.

**CLOSE CONNECTION TO THE COMPANY**

Matthias Altendorf has been CEO of the Endress+Hauser Group since 2014. He began his career at the company as an apprentice mechanic before proceeding to earn a degree, spending time abroad and undertaking further training. Even as an apprentice, the family business spirit fascinated him. He found the company’s founder to be an approachable employer: “We apprentices once took a trip by train to Locarno. Georg H Endress came along and enjoyed it with us. He knew that young people are the future. Personal growth was important to him.” Matthias Altendorf (born in 1967) is married and the father of an adult son. In his free time he enjoys sailing, chess, motorcycling and forestry work. His other hobbies include traveling, art and reading.

**Genge:** I am very optimistic that we will continue being able to do so in the future. The family remains visible and tangible for people at the company. The fact that we have opened up working opportunities at every level contributes in both respects. Two of my cousins recently completed internships at Endress+Hauser companies. And I can say with considerable certainty that these two young women were not the only ones who found it inspiring!

**As CEO, how important is the shareholder family to you – and how important is the fact that Endress+Hauser is a family business?**

**Altendorf:** For me personally, it is exceptionally important to work for a company whose values I share. As CEO, I live on the trust that the family grants me. The family entrusts me and the company’s management with all of its employees and assets. We strive to guide this company wisely and continue its successful development. It is important that we also establish a trustful relationship with the younger generation. To this end we must work with each other, learn from each other and listen to each other.

**How do you experience shareholder and family influence over the company?**

**Altendorf:** Thanks to the family’s trust, I have an insight into all of its institutions and committees. That benefits both sides. We collaborate to develop a consensual direction for the company’s long-term development. This give-and-take is a challenge for every family business. At publicly traded companies, the roles are clearly assigned. A family business requires greater tact and mutual understanding. However, this interplay also makes us more successful than other companies, since constant dialog leads to better, sustainable decisions.

**Genge:** It is important that we, as the shareholders, allow the management entrepreneurial freedom. Only in this way can Endress+Hauser stay successful.

# Imprint

**changes**  
The Endress+Hauser magazine

**Contact**  
Endress+Hauser AG  
Kägenstrasse 2  
4153 Reinach BL  
Switzerland

**Publisher**  
Matthias Altendorf

**Editorial team**  
Christine Böhringer, Robert Habi, Laurin Paschek,  
Martin Raab (editorial management), Kirsten Wörnle

**Art direction**  
Teresa Bungert, Katrin Janka

**Project team**  
David Bosshard, Corinne Fasana, Sereina  
Manetsch, Selina Meier, Kristina Rodriguez,  
Sandra Rubart, Sascha Stadelbacher

**Contributors**  
Richard Backhaus, Silke Bauer, Roman Scherer,  
Alexandra Schröder, Lisa Schwarz

**Translation, language adaption**  
Daniel Hawpe, Lennon Language Solutions,  
Jan Sinstadt, Helen White

**Photography**  
Manu Agah, Endress+Hauser, Christoph Fein,  
Getty Images, Jekaterina Gluzman, Andreas Mader,  
Kristoff Meller, Shutterstock, stocksy, Andreas  
Zimmermann

**Illustration**  
Julia Praszma, 3st kommunikation

**Design, production, picture editing**  
3st kommunikation GmbH, Mainz / Germany

**Printing**  
+siggset+ print & media AG, Albbbruck / Germany

‘changes’ is published in Chinese, English, French,  
German and Spanish. Please order additional  
copies by emailing [changes@endress.com](mailto:changes@endress.com).

Read more ‘changes’ stories online at  
[changes.endress.com](http://changes.endress.com)

Climate-neutral printing





# People for Process Automation

Endress+Hauser 